

*Sunbeam*

# Slurples

## Slushie Drink Maker

Instruction Booklet  
SL4600

Please read these  
instructions carefully  
and retain for future  
reference.



# Contents

<b>Sunbeam's Safety Precautions</b>	<b>1</b>
<b>Features of your Slurples slushie drink maker</b>	<b>2</b>
<b>Assembly Instructions</b>	<b>4</b>
<b>Using your Slurples</b>	<b>5</b>
<b>Dispensing your slushie drink</b>	<b>6</b>
<b>Slushie drink suggestions and tips</b>	<b>7</b>
<b>Care and Cleaning</b>	<b>8</b>

## Important instructions – retain for future use.

تأكد من تفهم احتياطات السلامة المذكورة اعلاه

請務必理解上述的安全預防措施。

Assurez-vous que les précautions ci-dessus relatives à la sécurité sont bien comprises

Versichern Sie sich, dass die obenstehenden Sicherheitsmaßnahmen Verstanden werden

Βεβαιώνετε πως οι παραπάνω προφυλάξεις ασφαλείας γίνονται κατανοητές

Pastikan bahwa tindakan-tindakan keselamatan seperti di atas dimengerti anda

Accertatevi che le suddette norme di sicurezza siano comprese a dovere

上記の注意事項をよくお読みになり、安全を御確認ください

Уверете се дека погоре споменатите мерки на претпазливост се добро разбрани

Asegúrese de que las precauciones de seguridad precedentes sean bien comprendidas

کاری بکنید کہ احتیاطهای بالا حتماً درک بشوند

ต้องแน่ใจว่า ข้อควรระวังเรื่องความปลอดภัยข้างต้น เป็นที่เข้าใจกันดี

Yukarda belirtilen güvenlik önlemlerinin anlaşılığundan emin olunuz

Xin kiểm chắc rằng những biện pháp làm an toàn kể trên được hiểu rõ

# Sunbeam's Safety Precautions

## SAFETY PRECAUTIONS FOR SLURPLES THE SLUSHIE DRINK MAKER.

- This appliance is not a toy.
- Operate the slushie drink maker on a flat surface.
- Do not leave your slushie drink maker unattended.
- Do not place any part of this appliance in a dishwasher.
- Do not add more than the recommended amount of salt.
- Do not place ice canister in freezer.

---

**Sunbeam are very safety conscious when designing and manufacturing consumer products, but it is essential that the product user also exercise care when using an electrical appliance. Listed below are precautions which are essential for the safe use of an electrical appliance:**

- Read carefully and save all the instructions provided with an appliance.
- Always turn the power off at the power outlet before you insert or remove a plug. Remove by grasping the plug - do not pull on the cord.
- Turn the power off and remove the plug when the appliance is not in use and before cleaning.
- Do not use your appliance with an extension cord unless this cord has been checked and tested by a qualified technician or service person.
- Always use your appliance from a power outlet of the voltage (A.C. only) marked on the appliance.
- This appliance is not intended for use by young children or infirm persons unless they have been adequately supervised by a responsible adult to ensure that they can use the appliance safely.
- Young children should be supervised to ensure that they do not play with the appliance.
- Never leave an appliance unattended while in use.
- Do not use an appliance for any purpose other than its intended use.
- Do not place an appliance on or near a hot gas flame, electric element or on a heated oven. Do not place on top of any other appliance.
- Do not let the power cord of an appliance hang over the edge of a table or bench top or touch any hot surface.
- Do not operate any electrical appliance with a damaged cord or after the appliance has been damaged in any manner. If damage is suspected, return the appliance to the nearest Sunbeam Appointed Service Centre for examination, repair or adjustment.
- For additional protection, Sunbeam recommend the use of a residual current device (RCD) with a tripping current not exceeding 30mA in the electrical circuit supplying power to your appliances.
- Do not immerse the appliance in water or any other liquid unless recommended.

If you have any concerns regarding the performance and use of your appliance, please visit [www.sunbeam.com.au](http://www.sunbeam.com.au) or contact the Sunbeam Consumer Service Line.

**Ensure the above safety precautions are understood.**

# Features of your Slurples slushie drink maker

---

## Salt dispensing cap

Used for measuring salt and adding salt.

---

## Jug

---

## Dispensing tap

Turn the dispensing tap when your slushie drink is ready to serve.

---

## Removable drip tray

Catches any drips and is removed for easy cleaning.

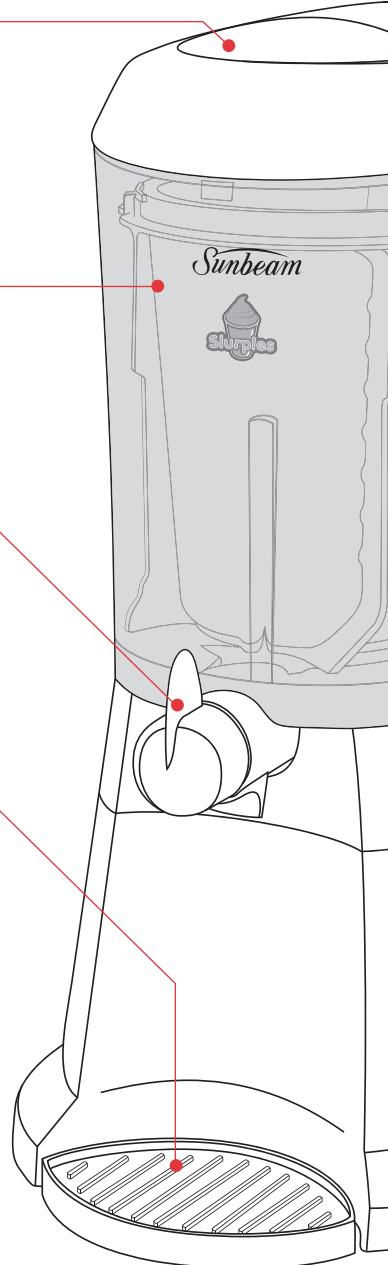

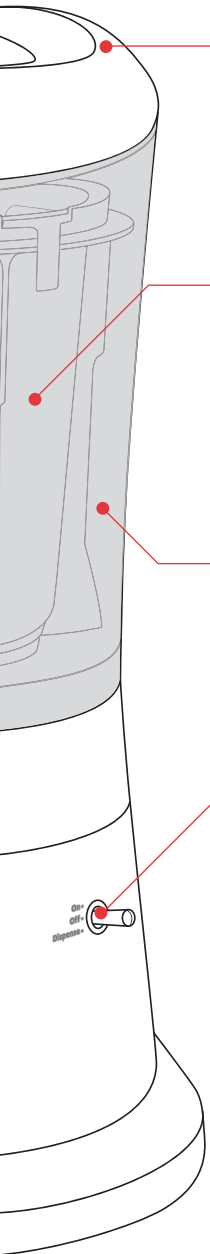

**Lid**

**Ice canister**

Ice and salt go into the ice canister to make Slurples super cold, super fast!

**Slushie paddles**

**Power switch**

On/Off/Dispense.

# Assembly Instructions

1. Before using your Slurples for the first time ensure that all packing material is removed.
2. Wash all parts in warm soapy water, rinse well and dry.
3. Place the base on a level benchtop. Place the Slurples jug on top of the motor base and ensure that it sits firmly in place with the dispensing tap over the drink tray. Figure 1.

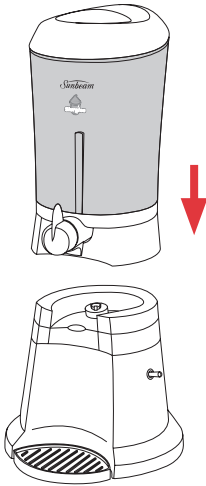

Figure 1

4. Insert the ice canister to fit inside the outer slushie paddles. Then insert the inner ice paddles to fit inside the ice canister. Figure 2.

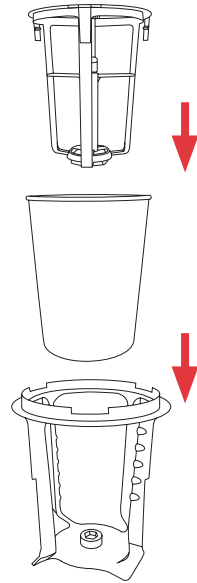

Figure 2

5. Clip in the locking latches on the inner ice paddles into the outer slushie paddles. Figure 3.

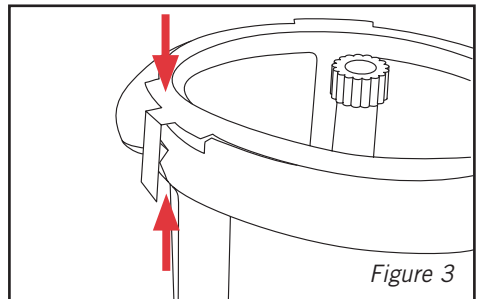
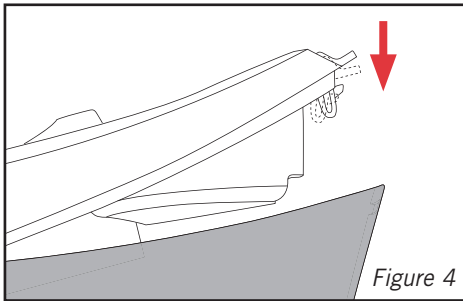

Figure 3

6. Place the canister with assembled inner and outer paddles into the Slurples jug. Ensure that the canister sits flush on the base of the jug.

# Using your Slurples

1. Turn Slurples to the 'off' setting on the side switch.
2. Plug the unit into a 230 -240 volt AC power outlet and switch the power on.
3. Secure the lid on to the Slushie jug.  
Place the front end on first, then secure the locking latch onto the rear clip of the canister. See Figure 4.



4. Turn the side switch to 'on'. The inner and outer paddles will start to rotate.
  5. Slowly pour the chilled drink mixture into the rear section of the lid. You will see the drink mixture through the jug being churned by the paddles.
- Important:** Do not place more than 1 litre (to the MAX line) of drink mixture in Slurples.
6. To fill the inside of the canister, remove the cap from the lid and add ice cubes through the lid opening to half fill the canister (this will take about 8 -10 standard size ice cubes). When the canister is half full of ice, turn the cap upside down and fill with rock salt. Add the rock salt to the ice.

**Note:** Regular square ice cubes work best in Slurples.

7. Add another 8 -10 standard size ice cubes through the lid opening until the ice reaches the maximum fill indicator disk on the inside of the canister, then add another capful of rock salt.

**Important:** Do not overfill above the maximum fill indicator disk with ice and rock salt. See Figure 5.

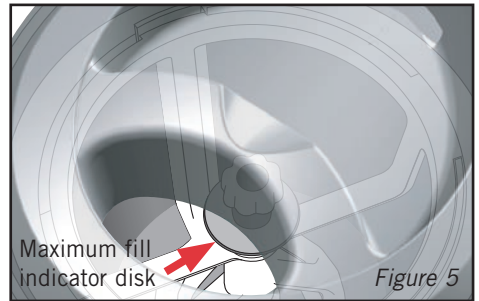

8. Pour ¼ cup (60ml) of water over the top of the rock salt and ice.
  9. Place the cap back on the lid.
  10. Leave the unit running for 10 to 15 minutes, depending on the desired 'slushie' consistency.
- Note:** A warmer room temperature may increase this time.
11. After 5-7 minutes check the ice and rock salt mixture through the lid opening. If the ice has melted, add a few more ice cubes and ½ capful of rock salt at a time.

**Important:** Do not fill to the top of the canister with ice and rock salt.

# Dispensing your Slushie drink

1. When peaks form in the slushie mixture, adjacent to the paddles the mixture has reached a good consistency.
2. Turn the side switch setting to the 'Dispense' setting to serve the slushie drink. This will reverse the paddle direction.
3. Place a glass underneath the dispensing tap and turn to the 'pour' position.
4. The slushie mixture will dispense from the tap into your glass.
5. To turn the dispenser off and to stop the flow, turn the tap counter clockwise.
6. Set the side switch to 'on' to continue mixing. Or switch to the 'off' position when you have finished using Slurples.



# Slushie drink suggestions

- All drinks should be chilled before adding to Slurples.
- Soft drinks work best in Slurples.
- Use your favourite cordial in Slurples. We recommend using more than the suggested concentrate amount when mixing with water as when cordial freezes, the flavour is not as concentrated.
- Fruit juice drinks can be used in Slurples. 100% fruit juice is not suitable as it will freeze the paddles to the canister. We recommend using fruit juice drinks which are 35% real fruit juice only.
- Diet soft drinks will not work in Slurples.
- Frozen cocktails can be made using Slurples but do not add alcohol until approximately 1-2 minutes before dispensing.

# Care and Cleaning

1. Set the side switch to the 'off' position and remove the plug from the power point.
2. Remove lid from the Slurples jug.
3. Remove the ice canister from the jug and discard any remaining ice and salt.
4. Carefully lift the locking latches from the ice paddles and disassemble the inner and out paddles from the canister.
5. Place the ice canister, paddles, lid and cap in warm soapy water and rinse in cold water.

**Note:** The ice canister and paddles must be separated before washing to remove any excess salt. Ensure that no salt is left in contact with the canister.

6. To clean the Slurples jug, rinse under warm water. Turn the dispensing handle clockwise to allow water to rinse through the tap.

**Never** immerse the Slurples base in water.

7. Wipe the base of Slurples with a warm cloth to clean.

**Important:** DO NOT PLACE ANY PART IN THE DISHWASHER.

# 12 Month Replacement Guarantee

We are so confident of the quality of our product, should this appliance develop any malfunction within 12 months of purchase (3 Months commercial use) due to faulty materials or manufacture, we will replace it for you absolutely free.

Should you experience any difficulties with your appliance, please phone our free call customer service line for advice on 1800 025 059 in Australia, or 0800 786 232 in New Zealand.

Alternatively, simply return the faulty appliance to your place of purchase, along with your purchase receipt.

Your Sunbeam 12 Month Replacement Guarantee naturally does not cover misuse or negligent handling, and excludes breakables such as glass or ceramic items, and normal wear and tear.

Similarly, your 12 Month Replacement Guarantee does not cover damage to household surfaces as a result of water or other substances leaking from your appliance, nor does it cover freight costs.

In Australia, this guarantee is additional to the conditions and guarantees which are mandatory as implied under the Trade Practices Act 1974 and State and Territory legislation.

## **Sunbeam Service Centres**

Sunbeam has established a network of authorised service centres throughout Australia and New Zealand to provide quick, convenient service for our customers.

Should your appliance require repair or service, either during or after the guarantee period, contact your nearest service centre.

For a complete list of Sunbeam's authorised service centres:

### **Australia**

[www.sunbeam.com.au/servicecentres](http://www.sunbeam.com.au/servicecentres)  
1800 025 059

### **New Zealand**

[www.sunbeam.co.nz/servicecentres](http://www.sunbeam.co.nz/servicecentres)  
0800 786 232

*Sunbeam*

## Consumer Hotline

In Australia

Visit [www.sunbeam.com.au](http://www.sunbeam.com.au)

Or call 1800 025 059

In New Zealand

Visit [www.sunbeam.co.nz](http://www.sunbeam.co.nz)

Or call 0800 786 232

*Sunbeam*

is a registered Trademark of Sunbeam.

'Sunbeam Slurples' is a trademark of Sunbeam Corporation.

Made in China.

Due to minor changes in design or otherwise,  
the product may differ from the one shown in this leaflet.

© Copyright. Sunbeam Corporation Limited 2006.

ABN 45 000 006 771

Sunbeam Corporation is a division of GUD Holdings Ltd.